



LED LAMP REFERENCE GUIDE

JANUARY, 2019

Hi-Pro LED lamps

High lumen, omni-directional lamps for industrial and commercial applications

- Replaces HID, CFL, and Incandescent
- Direct wire range voltage 100-277V
- Built-in surge protection 80-120W
- Approved for totally enclosed fixtures**
- IP65 rated
- 3 CCT options
- High bay/low bay/post top
- DLC listed*
- Long life—50,000 hours
- 5 Year limited warranty



High Lumen Industrial/Commercial LED Lamps



Item Number	Lamp Description	Replaces Inc/CFL/HID	W	V	Base Type	CCT	Lm	M.O.L. (Inches)	Life/ Hrs.	UPC	Pack/ Master
S29670	18W/LED/HID/2700K/100-277V	120/32/70	18	100-277	E26	2700K	2200	6 7/8	50K	045923296703	48
S29390	18W/LED/HID/5000K/100-277V	120/32/70	18	100-277	E26	5000K	2700	6 7/8	50K	045923293900	48
S9678	18W/LED/HID/AMBER/100-277V	—	18	100-277	E26	Amber	—	6 7/8	50K	045923096785	48
S29671	22W/LED/HID/2700K/100-277V	150/40/100	22	100-277	E26	2700K	2680	7 11/16	50K	045923296710	48
S29391	22W/LED/HID/5000K/100-277V	150/40/100	22	100-277	E26	5000K	2950	7 11/16	50K	045923293917	48
S29672	36W/LED/HID/2700K/100-277V	200/55/150	36	100-277	E26	2700K	4390	9 1/4	50K	045923296727	12
S29392	36W/LED/HID/5000K/100-277V	200/55/150	36	100-277	E26	5000K	4800	9 1/4	50K	045923293924	12
S9489	36W/LED/HID/AMBER/100-277V	—	36	100-277	E26	Amber	—	9 1/4	50K	045923094897	12
S29673*	45W/LED/HID/4000K/120-277V	300/65/175	45	100-277	EX39	4000K	5850	10 3/4	50K	045923296734	12
S29393*	45W/LED/HID/5000K/100-277V	300/65/175	45	100-277	EX39	5000K	6000	10 3/4	50K	045923293931	12
S29674*	54W/LED/HID/4000K/120-277V	300/85/250	54	100-277	EX39	4000K	7020	10 3/4	50K	045923296741	12
S29394*	54W/LED/HID/5000K/100-277V	300/85/250	54	100-277	EX39	5000K	7200	10 3/4	50K	045923293948	12
S29675*	80W/LED/HID/4000K/120-277V	400/100/320	80	100-277	EX39	4000K	10400	9 1/4	50K	045923296758	6
S29395*	80W/LED/HID/5000K/100-277V	400/100/320	80	100-277	EX39	5000K	10640	9 1/4	50K	045923293955	6
S29676*	100W/LED/HID/4000K/100-277V	500/150/400	100	100-277	EX39	4000K	13000	9 5/8	50K	045923296765	6
S29396*	100W/LED/HID/5000K/100-277V	500/150/400	100	100-277	EX39	5000K	13300	9 5/8	50K	045923293962	6
S29677*	120W/LED/HID/4000K/100-277V	750/200/600	120	100-277	EX39	4000K	15600	10 3/8	50K	045923296772	6
S29397*	120W/LED/HID/5000K/100-277V	750/200/600	120	100-277	EX39	5000K	16000	10 3/8	50K	045923293979	6

Accessories

92-410	Mog to Med Socket Reducer for S29390, S29391, S29392, S29670, S29671 and S29672	045923924064
80-929	Hard Wire Surge Protector	045923809293

** For minimum compartment size of enclosed fixture visit www.satco.com. Lamp life may vary depending on application and use. See warranty for details.

HIGH LUMEN LED LAMPS

Hi-Pro 277-347V high lumen LED lamps

High lumen, omni-directional lamps for industrial and commercial applications

- Replaces HID, CFL, and Incandescent
- Direct wire range voltage 277-347V
- Built-in surge protection 80-120W
- Approved for totally enclosed fixtures**
- IP65 rated
- 5000K
- Beam angle 300°
- CRI 80+
- High bay/low bay/post top
- DLC listed*
- 5 Year limited warranty



S28710, S28711
S28712

S28713, S28714

S28715, S28716

S28717

High Lumen Industrial/Commercial 277-347V LED Lamps



Item Number	Lamp Description	Replaces Inc/CFL/HID	W	V	Base Type	CCT	Lm	M.O.L. (Inches)	Life/ Hrs.	UPC	Pk/ Mstr.
S28710	18W/LED/HID/5000K/277-347V/E26	120/32/70	18	277-347	E26	5000K	2400	6 3/4	40K	045923287107	48
S28711	22W/LED/HID/5000K/277-347V/E26	150/40/100	22	277-347	E26	5000K	2950	6 1/16	40K	045923287114	48
S28712	36W/LED/HID/5000K/277-347V/E26	200/55/150	36	277-347	E26	5000K	4800	9 3/16	40K	045923287121	12
S28713*	45W/LED/HID/5000K/277-347V/EX39	300/65/175	45	277-347	EX39	5000K	6000	10 11/16	40K	045923287138	12
S28714*	54W/LED/HID/5000K/277-347V/EX39	300/85/250	54	277-347	EX39	5000K	7200	10 11/16	40K	045923287145	12
S28715*	80W/LED/HID/5000K/277-347V/EX39	400/100/320	80	277-347	EX39	5000K	10640	9 1/4	40K	045923287152	4
S28716*	100W/LED/HID/5000K/277-347V/EX39	500/150/400	100	277-347	EX39	5000K	13300	9 5/8	40K	045923287169	4
S28717*	120W/LED/HID/5000K/277-347V/EX39	750/200/600	120	277-347	EX39	5000K	16000	10 3/8	40K	045923287176	4

Accessories

92-410	Mog to Med Socket Reducer									045923924064	
80-935	Hard Wire Surge Protector									045923809354	

** For minimum compartment size of enclosed fixture visit www.satco.com. Lamp life may vary depending on application and use. See warranty for details.

HIGH LUMEN LED LAMPS

Hi-Pro LED 12-24V low voltage lamps

Low voltage, high lumen, omni-directional lamps for industrial and commercial applications

- Replaces HID, CFL, and Incandescent
- Approved for totally enclosed fixtures**
- IP65 rated
- 5000K
- Long life—50,000 hours
- 5 Year limited warranty



S9753

S9754

S9755



High Lumen Industrial/Commercial LED Lamps - 12-24V

Item Number	Lamp Description	Replaces INC/HID	W	V	Base Type	CCT	Lm	M.O.L. (Inches)	Life/Hrs.	UPC	Pack
S9753	10W/LED/HID/5000K/12V-24V E26	90/30	10	12-24	E26	5000K	1200	5 13/16	50K	045923097539	48
S9754	14W/LED/HID/5000K/12V-24V E26	150/50	14	12-24	E26	5000K	1680	6 3/16	50K	045923097546	48
S9755	18W/LED/HID/5000K/12V-24V E26	200/70	18	12-24	E26	5000K	2160	7	50K	045923097553	48

** For minimum compartment size of enclosed fixture visit www.satco.com. Lamp life may vary depending on application and use. See warranty for details.

Hi-Pro LED lamps with motion sensor

High lumen, omni-directional lamps with adjustable motion sensor for industrial and commercial applications

- Replaces HID, CFL, and Incandescent
- Direct wire range voltage 100-277V
- Approved for totally enclosed fixtures**
- Microwave sensor
- 3000K, 5000K
- 5 Year limited warranty



Adjustable motion sensor

Adjustable Motion Sensor
Adjust the position and angle of the motion sensor according to the fixtures.

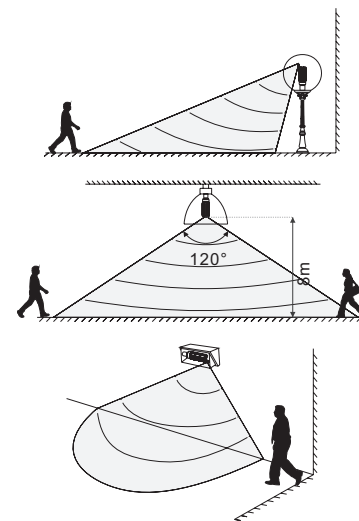

High Lumen Industrial/Commercial LED Lamps with Motion Sensors

Item Number	Lamp Description	Replaces Inc/CFL/HID	W	V	Base Type	CCT	Lm	M.O.L. (Inches)	Life/Hrs.	UPC	Pk/Mstr.
S8988	63W/LED/HID/3K/MS/100-277V	300/85/250	63	100-277	E39	3000K	7875	10 7/8	50K	045923089886	12
S8989	63W/LED/HID/5K/MS/100-277V	300/85/250	63	100-277	E39	5000K	7875	10 7/8	50K	045923089893	12

** For minimum compartment size of enclosed fixture visit www.satco.com. Lamp life may vary depending on application and use.

HIGH LUMEN LED LAMPS

Hi-Pro LED shoe box lamp series

High lumen, directional lamps for industrial and commercial fixture applications

- For use in shoe box fixtures
- 80/110 Watt options (10,000/14,000 lm) replaces 250/400 Watt HID
- Replaces HID
- Approved for totally enclosed fixtures**
- Damp location
- Direct wire range voltage 100-277V
- Higher efficiency, improved heat dissipation
- 2 CCT options
- Expandable 180° beam design with adjustable base (E39)
- Horizontal operation
- DLC listed*
- Long life—50,000 hours
- 5 Year limited warranty

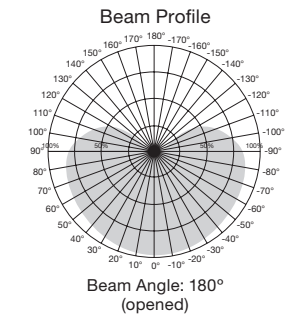
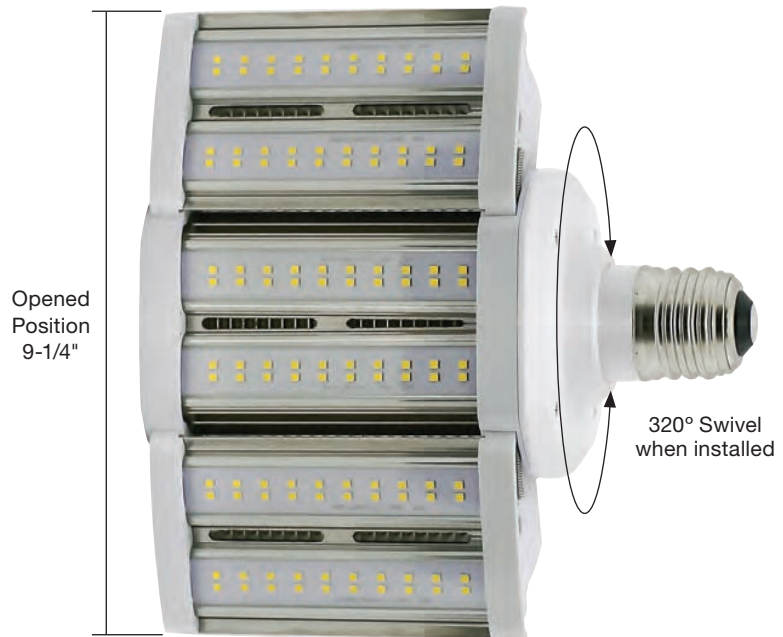

High Lumen Industrial/Commercial LED Lamps



Item Number	Lamp Description	W	V	Rpl.	Base Type	CCT	Lm	Bm	M.O.L. (Inches)	Life/Hrs.	UPC	Pack
S8931*	80W/LED/HID/SB/3K/E39/100-277V	80	100-277	250W	E39	3000K	10000	180°	8 1/16	50K	045923089312	4
S8932*	80W/LED/HID/SB/5K/E39/100-277V	80	100-277	250W	E39	5000K	10000	180°	8 1/16	50K	045923089329	4
S8937*	110W/LED/HID/SB/3K/E39/100-277V	110	100-277	400W	E39	3000K	14000	180°	11 1/8	50K	045923089374	4
S8938*	110W/LED/HID/SB/5K/E39/100-277V	110	100-277	400W	E39	5000K	14000	180°	11 1/8	50K	045923089381	4

Accessories

80-929 Hard Wire Surge Protector

045923809293

** For minimum compartment size of enclosed fixture visit www.satco.com. Lamp life may vary depending on application and use. See warranty for details.

Hi-Pro LED wall pack lamp series

High lumen, directional lamps for industrial and commercial fixture applications

- For use in wall pack, canopy, shoe box, or cobra head fixtures
- 20/40/60 Watt options replaces 100/175/250 Watt HID
- Replaces HID
- Approved for totally enclosed fixtures**
- Direct wire range voltage 100-277V
- IP64, higher efficiency, improved heat dissipation
- Reduced size
- 180° beam/adjustable base (E26/E39)
- Horizontal operation
- DLC listed*
- Long life—50,000 hours
- 5 Year limited warranty

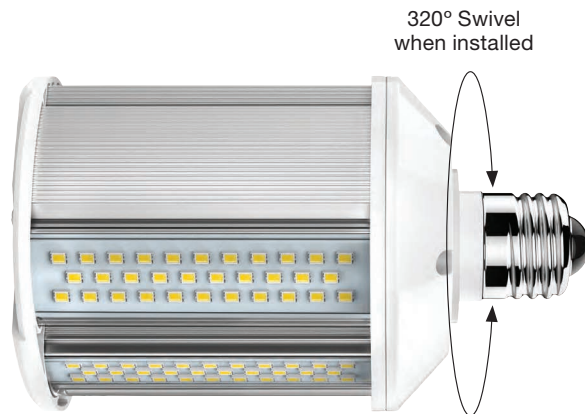

320° Swivel when installed

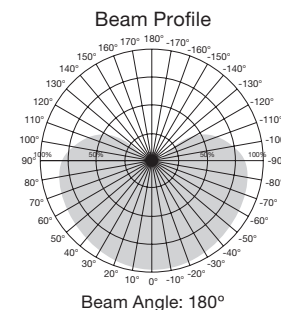

High Lumen Industrial/Commercial LED Lamps



Item Number	Lamp Description	W	V	Rpl.	Base Type	CCT	Lm	Bm	M.O.L. (Inches)	Life/Hrs.	UPC	Pack
S8928	20W/LED/HID/WP/5K/E26/100-277V	20	100-277	100W	E26	5000K	3000	180°	5 ¼	50K	045923089282	12
S8929	40W/LED/HID/WP/5K/E26/100-277V	40	100-277	175W	E26	5000K	6000	180°	7 ⅞	50K	045923089299	12
S8930*	40W/LED/HID/WP/5K/E39/100-277V	40	100-277	175W	E39	5000K	6000	180°	8 ½	50K	045923089305	12
S8987*	60W/LED/HID/WP/5K/E39/100-277V	60	100-277	250W	E39	5000K	9000	180°	10 ¾	50K	045923089879	12

Accessories												
92-410	Mog to Med Socket Reducer for S9750										045923924064	
80-929	Hard Wire Surge Protector										045923809293	

** For minimum compartment size of enclosed fixture visit www.satco.com. Lamp life may vary depending on application and use. See warranty for details.

HIGH LUMEN LED LAMPS

Hi-Pro LED multi-beam lamps

High lumen, adjustable, multi-directional lamps for industrial and commercial applications

- Replaces HID, CFL, and incandescent
- Direct wire range voltage 100-277V
- Approved for totally enclosed fixtures**
- High bay, low bay, hanging sockets, and post top
- 2700K or 5000K
- Light panels lock into place creating 3 separate beam angle options
- IP65 rated
- Long life—50,000 hours
- 5 Year limited warranty



360° Beam



270° Beam



180° Beam

High Lumen Multi-Beam Industrial/Commercial LED Lamps



Item Number	Lamp Description	Replaces Inc/CFL/HID	W	V	Base Type	CCT	Lm	CRI	M.O.L. (Inches)	Life/Hrs.	UPC	Pack/Master
S29768	30W/LED/HID/MB/2700K/100-277V	200/55/150	30	100-277	E26	2700K	3660	83	6 3/8	50K	045923297687	24
S29750	30W/LED/HID/MB/5000K/100-277V	200/55/150	30	100-277	E26	5000K	3900	83	6 3/8	50K	045923297502	24
S29798	40W/LED/HID/MB/2700K/100-277V	300/65/175	40	100-277	EX39	2700K	4880	83	7 7/8	50K	045923297984	12
S29751	40W/LED/HID/MB/5000K/100-277V	300/65/175	40	100-277	EX39	5000K	5200	83	7 7/8	50K	045923297519	12
S29799	60W/LED/HID/MB/2700K/100-277V	500/85/250	60	100-277	EX39	2700K	7320	83	8 9/16	50K	045923297991	12
S29752	60W/LED/HID/MB/5000K/100-277V	500/85/250	60	100-277	EX39	5000K	7800	83	8 9/16	50K	045923297526	12
S29769	75W/LED/HID/MB/5000K/100-277V	750/105/400	75	100-277	EX39	5000K	9800	80+	8 3/8	50K	045923297694	12
S29679	90W/LED/HID/MB/5000K/100-277V	750/200/600	90	100-277	EX39	5000K	11700	80+	8 3/8	50K	045923296796	4

Accessories

92-410	Mog to Med Socket Reducer for S29750, S29768 and S29750	045923924064
80-929	Hard Wire Surge Protector	045923809293

** For minimum compartment size of enclosed fixture visit www.satco.com. Lamp life may vary depending on application and use. See warranty for details.

PATENT PENDING

Hi-Pro LED high bay/low bay "power flood" lamps

High lumen, LED lamps for industrial and commercial applications

- Replaces HID, CFL, and Incandescent
- 120° beam angle
- Long neck option fits more fixtures
- Direct wire range voltage 120-277V
- Light weight
- Advanced passive heat dissipation
- DLC listed*
- Long life—50,000 hours
- 5 Year limited warranty

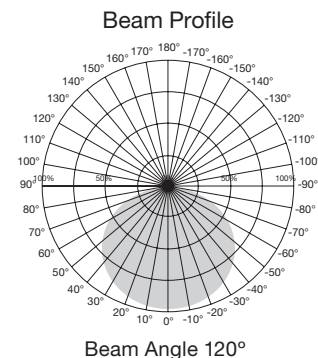

High Lumen Industrial/Commercial LED Lamps

Item Number	Lamp Description	Replaces INC/CFL/HID	W	V	Base Type	CRI	CCT	Lm	Bm	M.O.L. (Inches)	Life/Hrs.	UPC	Pack/Mstr.
S8776*	60W/LED/HID-HB/5000K/120-277V	500/150/250	60	120-277	E39	80+	5000K	7200	120°	9 1/8	50K	045923087769	6
S8777*	75W/LED/HID-HB/5000K/120-277V	750/200/400	75	120-277	E39	80+	5000K	9010	120°	10 13/16	50K	045923087776	4

Accessories

80-929 HARD WIRE SURGE PROTECTOR

045923809293

Hi-Pro LED post top lamps

- For use in any post top fixture to provide light out and down only
- Direct wire (ballast by-pass) 100-277V / E26
- Approved for enclosed fixtures**
- Long life—50,000 hours
- 5 Year limited warranty

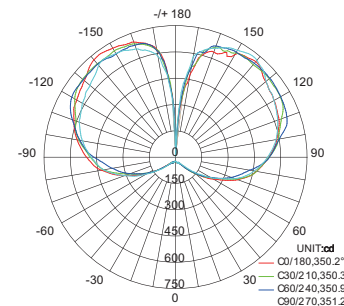

Controls light pollution



High Lumen LED Lamps

Item Number	Lamp Description	W	V	Base Type	CRI	CCT	Lm	M.O.L. (Inches)	Life/Hrs.	UPC	Pack/Mstr.
S9779	40W/LED/HID/PT/3000K/100-277V	40	100-277	E26	80+	3000K	5000	5 1/2	50K	045923097799	12

Accessories

92-410 Mog to Med Socket Reducer

045923924064

80-929 Hard Wire Surge Protector

045923809293

** See warranty for details.

HIGH LUMEN LED PAR LAMPS

Hi-Pro LED PAR30 lamps

High lumen, PAR lamps for industrial and commercial applications

- Replaces Halogen and ceramic metal Halide lamps
- Saves over 80% on energy costs
- Direct wire range voltage 100-277V
- High efficiency—100LPW
- 3000 and 4000K options
- Base up, base down or horizontal operation
- Long life—50,000 hours
- ENERGY STAR certified*
- 5 Year limited warranty



S9762, S9763

S9764, S9765

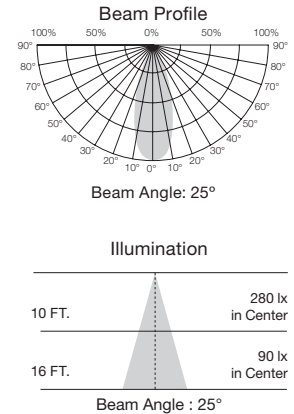

High Lumen PAR30 Industrial/Commercial LED Lamps

Item Number	Lamp Description	W	V	CRI	CCT	Lm	Bm	M.O.L. (Inches)	Life/ Hrs.	UPC	Pack/ Master
S9762*	12W/LED/PAR30/SN/3K/100-277V	12	100-277	83	3000K	1200	25°	3 1/2	50K	045923097621	24/6
S9763*	12W/LED/PAR30/SN/4K/100-277V	12	100-277	83	4000K	1200	25°	3 1/2	50K	045923097638	24/6
S9764*	12W/LED/PAR30/LN/3K/100-277V	12	100-277	83	3000K	1200	25°	4 5/16	50K	045923097645	24/6
S9765*	12W/LED/PAR30/LN/4K/100-277V	12	100-277	83	4000K	1200	25°	4 5/16	50K	045923097652	24/6
Accessories											
80-929	HARD WIRE SURGE PROTECTOR									045923809293	

Hi-Pro LED PAR38 lamps

High lumen, PAR lamps for industrial and commercial applications

- Replaces Halogen and ceramic metal Halide lamps
- Saves over 80% on energy costs
- Direct wire range voltage 100-277V
- High efficiency—over 100LPW
- 3000 and 4000K options
- Base up, base down or horizontal operation
- Long life—50,000 hours
- ENERGY STAR certified*
- 5 Year limited warranty

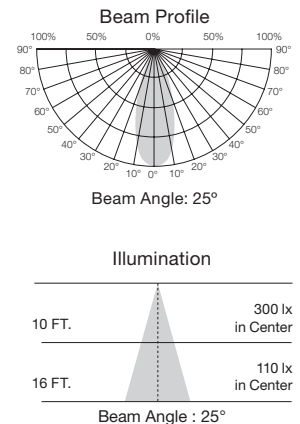

High Lumen PAR38 Industrial/Commercial LED Lamps

Item Number	Lamp Description	W	V	CRI	CCT	Lm	Bm	M.O.L. (Inches)	Life/ Hrs.	UPC	Pack/ Master
S9760*	18W/LED/PAR38/3000K/100-277V	18	100-277	83	3000K	1950	25°	5 1/16	50K	045923097607	12/6
S9761*	18W/LED/PAR38/4000K/100-277V	18	100-277	83	4000K	2000	25°	5 1/16	50K	045923097614	12/6
Accessories											
80-929	HARD WIRE SURGE PROTECTOR									045923809293	

HIGH LUMEN LED LAMPS



E39 Mogul Base

Screw terminals

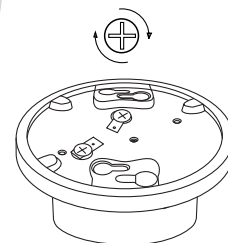

Instant hi-bay fixture

Keyless porcelain mogul base lamp holder with screw terminals

- Perfect for use with LED HID replacement lamps
- Commercial/industrial applications
- Screw-in eye hook for safety cable included
- Holder rated at 1500W Max.
- 600V
- Max lamp weight 5 lbs.



Lamp and cables not included



Screw-in safety eye hook included

Keyless Porcelain Mogul Base Lamp Holder



Item Number	Lamp Description	Max. W	Max. V	UPC	Pack
90-483	Keyless Mogul Lamp Holder	1500	600	045923904837	40

HIGH LUMEN LED LAMPS

Hi-Pro LED temporary hi-bay caged lamp series

High lumen, omni-directional lamps for industrial and commercial applications

- For use in any commercial work area replacing HID, CFL and Incandescent
- 60/100/150 Watt options (up to 15,000 lm)
- Includes 3' power cord/plug
- Portable
- Outlet for connecting multiple lamps
- Remote control "on/off"
- Cage is redesigned to be free standing with additional support
- IP64, higher efficiency, improved heat dissipation
- 360° Omni-directional light
- Damp location
- Long life—50,000 hours
- 5 Year limited warranty



S28939

S28946

S28975

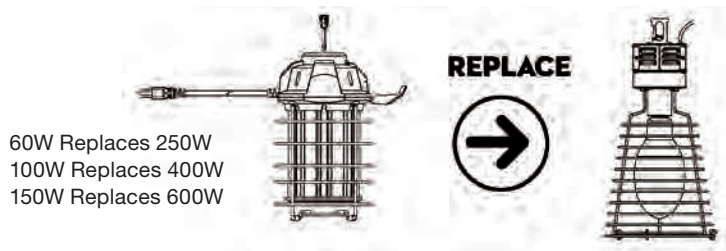

Linkable
60Wx10 pcs. max
100Wx6 pcs. max
150Wx4 pcs. max
600W max

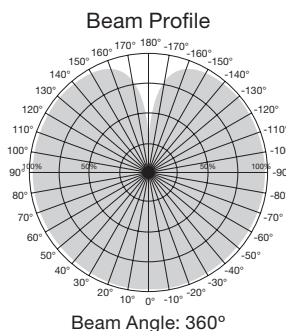

High Lumen Industrial/Commercial LED Lamps



Item Number	Lamp Description	Replaces	W	V	CRI	CCT	Lm	Bm	M.O.L. (Inches)	Life/Hrs.	UPC	Pack
S28939	60W/LED/HID/TEMP/5K/RC/120V	250W	60	120	85	5000K	6000	360°	10 1/16	50K	045923289392	4
S28946	100W/LED/HID/TEMP/5K/RC/120V	400W	100	120	85	5000K	10000	360°	12	50K	045923289460	4
S28975	150W/LED/HID/TEMP/5K/RC/120V	600W	150	120	85	5000K	15000	360°	13 3/8	50K	045923289750	4



Hi-Pro LED temporary string light series

High lumen, omni-directional string lights for industrial and commercial applications

- For use in any commercial work area
- 5 lamps per string
- 20W / 2000 lumens per lamp (100W)
- 10' between lamps (50' per string)
- Replaces HID, CFL, and Incandescent
- 360° Omni-directional light
- Direct wire 120V
- Wet location
- IP65 - Water and dust proof
- Long life—50,000 hours
- 3 Year limited warranty

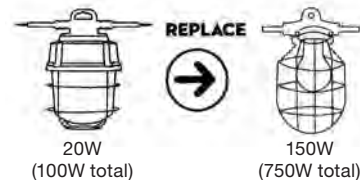

Beam Profile - Each Lamp

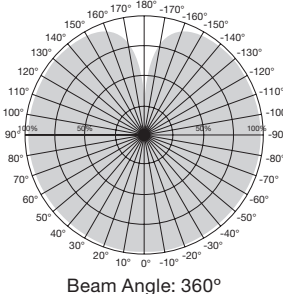

High Lumen Industrial/Commercial LED String Light



Item Number	Lamp Description	W	V	CRI	Base Type	CCT	Lm	Bm	M.O.L. (Inches)	Life/Hrs.	UPC	Pack
S8976	100W/LED/5PC/TEMP/STRING/120V	100	120	85	String/Plug	5000K	10000	360°	6 5/8	50K	045923089763	1

PL/LED BALLAST BYPASS LAMPS

PL/LED ballast bypass replacement lamps

- UL Classified
- 2-pin replacement for up to 26 Watt pin based CFL, uses only 9 Watts
- 2-pin LED lamps works in both 2-pin (magnetic) and 4-pin (electronic) sockets
 - G24d (2-pin)—18 and 26W rep.
 - G24q (4-pin)—13, 18, and 26 rep.
- Direct wire 120-277V
- Instant on to full brightness / no flickering
- Rotates up to 270° for various fixture applications
- Vertical and horizontal options
- Up to 70% energy saving
- Damp location
- Long life—50,000 hours
- 5 Year warranty

Rotates 270° when installed



S8530, S8531, S8532, S8533, S8534



S8535, S8536, S8537, S8538, S8539

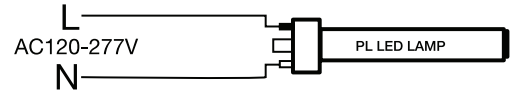
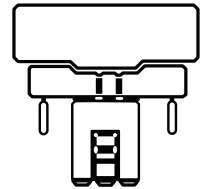
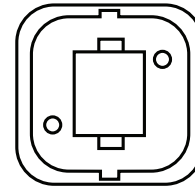

PL/LED Replacement Lamps



Item Number	Lamp Description	W	Base Type	CCT	CRI	M.O.L. (Inches)	Lm	Life/Hrs.	UPC	Pack/Master
S8530	9WPLH/LED/827/BP/2P	9	G24d	2700K	82	6 5/8	900	50K	045923085307	50/10
S8531	9WPLH/LED/830/BP/2P	9	G24d	3000K	82	6 5/8	950	50K	045923085314	50/10
S8532	9WPLH/LED/835/BP/2P	9	G24d	3500K	82	6 5/8	950	50K	045923085321	50/10
S8533	9WPLH/LED/840/BP/2P	9	G24d	4000K	82	6 5/8	1000	50K	045923085338	50/10
S8534	9WPLH/LED/850/BP/2P	9	G24d	5000K	82	6 5/8	1000	50K	045923085345	50/10
S8535	9WPLV/LED/827/BP/2P	9	G24d	2700K	82	4 1/4	900	50K	045923085352	50/10
S8536	9WPLV/LED/830/BP/2P	9	G24d	3000K	82	4 1/4	950	50K	045923085369	50/10
S8537	9WPLV/LED/835/BP/2P	9	G24d	3500K	82	4 1/4	950	50K	045923085376	50/10
S8538	9WPLV/LED/840/BP/2P	9	G24d	4000K	82	4 1/4	1000	50K	045923085383	50/10
S8539	9WPLV/LED/850/BP/2P	9	G24d	5000K	82	4 1/4	1000	50K	045923085390	50/10

LED/CFL direct replacement lamps

4-pin (electronic ballasts)
2-pin (magnetic ballasts)

- 4-pin 26, 32, 42 Watt direct replacement
- 2-pin 26 Watt direct replacement
- 4-pin lamps fit G24q-3 & GX24q-3 and GX24q-4 sockets
- 2-pin lamps fit G24d-3 sockets
- No re-wiring needed
- Instant on to full brightness / no flickering
- Vertical and horizontal options
- Up to 70% energy saving
- DLC listed* (4-pin only)
- c-UL-us listed
- Long life—50,000 hours
- 5 Year warranty



S29858, S29859,
S29860, S29861
G24Q



S9862, S9863,
S9864, S9865
G24D

Rotates 270°
when installed

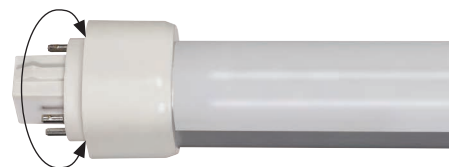

S29850, S29851, S29852, S29853
G24Q

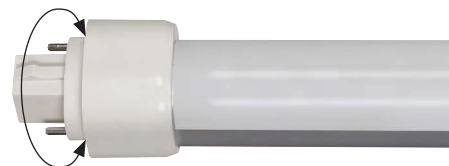

S9854, S9855, S9856, S9857
G24D

LED/CFL Replacement Lamps



Item Number	Lamp Description	W	Base Type	CCT	CRI	M.O.L. (Inches)	Lm	Life/ Hrs.	UPC	Pack/ Master
4-Pin Horizontal										
S29850*	9WPLH/LED/830/DR/4P	9	G24Q	3000K	82	6 5/8	950	50K	045923298509	50/10
S29851*	9WPLH/LED/835/DR/4P	9	G24Q	3500K	82	6 5/8	950	50K	045923298516	50/10
S29852*	9WPLH/LED/840/DR/4P	9	G24Q	4000K	82	6 5/8	900	50K	045923098529	50/10
S29853*	9WPLH/LED/850/DR/4P	9	G24Q	5000K	82	6 5/8	900	50K	045923298530	50/10
2-Pin Horizontal										
S9854	9WPLH/LED/830/DR/2P	9	G24D	3000K	82	6 5/8	850	50K	045923098543	50/10
S9855	9WPLH/LED/835/DR/2P	9	G24D	3500K	82	6 5/8	850	50K	045923098550	50/10
S9856	9WPLH/LED/840/DR/2P	9	G24D	4000K	82	6 5/8	900	50K	045923098567	50/10
S9857	9WPLH/LED/850/DR/2P	9	G24D	5000K	82	6 5/8	900	50K	045923098574	50/10
4-Pin Vertical										
S29858*	9WPLV/LED/830/DR/4P	9	G24Q	3000K	82	4 11/16	950	50K	045923298585	50/10
S29859*	9WPLV/LED/835/DR/4P	9	G24Q	3500K	82	4 11/16	950	50K	045923298592	50/10
S29860*	9WPLV/LED/840/DR/4P	9	G24Q	4000K	82	4 11/16	900	50K	045923298608	50/10
S29861*	9WPLV/LED/850/DR/4P	9	G24Q	5000K	82	4 11/16	900	50K	045923298615	50/10
2-Pin Vertical										
S9862	9WPLV/LED/830/DR/2P	9	G24D	3000K	82	4 11/16	850	50K	045923098628	50/10
S9863	9WPLV/LED/835/DR/2P	9	G24D	3500K	82	4 11/16	850	50K	045923098635	50/10
S9864	9WPLV/LED/840/DR/2P	9	G24D	4000K	82	4 11/16	900	50K	045923098642	50/10
S9865	9WPLV/LED/850/DR/2P	9	G24D	5000K	82	4 11/16	900	50K	045923098659	50/10

LED/CFL ballast bypass replacement lamps

2-Pin GX23 ballast bypass GU24 Base, E26 Base

- 2-Pin 13 Watt CFL direct replacement
- GU24 Base and E26 Base are 13-18 Watt CFL and 60 Watt incandescent direct replacements
- Instant on to full brightness / no flickering
- Rotates up to 270° for various fixture applications
- Vertical and horizontal options
- Up to 70% energy saving
- c-UL-us Classified—2-Pin ballast bypass
- c-UL-us listed—GU24 base, E26 base
- Long life—50,000 hours
- 5 Year warranty



2-Pin ballast bypass
S8725, S8726, S8728, S8729

Rotates 270°
when installed



GU24
S8745, S8746, S8747, S4748, S8749



E26
S8755, S8756, S8757, S4758, S8759

LED/CFL Replacement Lamps



Item Number	Lamp Description	W	V	Base Type	CCT	CRI	M.O.L. (Inches)	Lm	Life/Hrs.	UPC	Pack/Master
2-Pin Ballast Bypass—c-UL-us Classified											
S8725	6W/H/LED/CFL/827/2P/BP	6	120-277V	GX23	2700K	83	5 3/4	570	50K	045923087257	50/10
S8726	6W/H/LED/CFL/830/2P/BP	6	120-277V	GX23	3000K	83	5 3/4	570	50K	045923087264	50/10
S8727	6W/H/LED/CFL/835/2P/BP	6	120-277V	GX23	3500K	83	5 3/4	600	50K	045923087271	50/10
S8728	6W/H/LED/CFL/840/2P/BP	6	120-277V	GX23	4000K	83	5 3/4	600	50K	045923087288	50/10
S8729	6W/H/LED/CFL/850/2P/BP	6	120-277V	GX23	5000K	83	5 3/4	600	50K	045923087295	50/10
GU24 Base—c-UL-us listed											
S8745	8W/H/LED/CFL/827/GU24	8	120-277V	GU24	2700K	83	6 1/2	920	50K	045923087455	50/10
S8746	8W/H/LED/CFL/830/GU24	8	120-277V	GU24	3000K	83	6 1/2	920	50K	045923087462	50/10
S8747	8W/H/LED/CFL/835/GU24	8	120-277V	GU24	3500K	83	6 1/2	960	50K	045923087479	50/10
S8748	8W/H/LED/CFL/840/GU24	8	120-277V	GU24	4000K	83	6 1/2	960	50K	045923087486	50/10
S8749	8W/H/LED/CFL/850/GU24	8	120-277V	GU24	5000K	83	6 1/2	960	50K	045923087493	50/10
E26 Base—c-UL-us listed											
S8755	8W/H/LED/CFL/827/E26	8	120-277V	E26	2700K	83	6 13/16	920	50K	045923087554	50/10
S8756	8W/H/LED/CFL/830/E26	8	120-277V	E26	3000K	83	6 13/16	920	50K	045923087561	50/10
S8757	8W/H/LED/CFL/835/E26	8	120-277V	E26	3500K	83	6 13/16	960	50K	045923087578	50/10
S8758	8W/H/LED/CFL/840/E26	8	120-277V	E26	4000K	83	6 13/16	960	50K	045923087585	50/10
S8759	8W/H/LED/CFL/850/E26	8	120-277V	E26	5000K	83	6 13/16	960	50K	045923087592	50/10

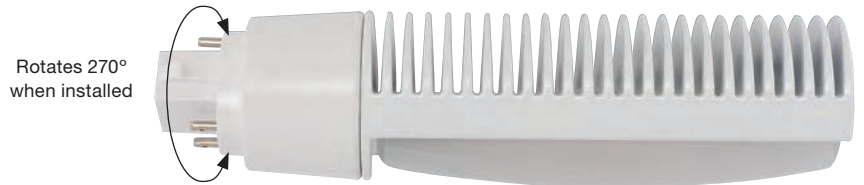

Rotates 270°
when installed

S21400, S21401, S21402, S21403



S21404, S21405, S21406, S21407

LED/CFL direct replacement lamps 4-pin (electronic ballasts)

- UL listed 4-pin 42 Watt direct replacement
- 4-pin lamps fit GX24q-4 sockets
- No re-wiring needed
- Instant on to full brightness / no flickering
- Vertical and horizontal options
- DLC Listed*
- c-UL-us listed
- Up to 60% energy saving
- Long life—50,000 hours
- 5 Year warranty

LED/CFL Replacement Lamps - Ballast Compatible♦



Item Number	Lamp Description	W	Base Type	CCT	CRI	M.O.L. (Inches)	Lm	Life/ Hrs.	UPC	Pk./ Mstr.
S21400*	PLT/16W/H/LED/830/4P/DR	16	G24Q	3000K	82	5 ¾	1750	50K	045923224003	20
S21401*	PLT/16W/H/LED/835/4P/DR	16	G24Q	3500K	82	5 ¾	1750	50K	045923224010	20
S21402*	PLT/16W/H/LED/840/4P/DR	16	G24Q	4000K	82	5 ¾	1850	50K	045923224027	20
S21403*	PLT/16W/H/LED/850/4P/DR	16	G24Q	5000K	82	5 ¾	1850	50K	045923224034	20
S21404*	PLT/16W/V/LED/830/4P/DR	16	G24Q	3000K	82	6 ½	1750	50K	045923224041	20
S21405*	PLT/16W/V/LED/835/4P/DR	16	G24Q	3500K	82	6 ½	1750	50K	045923224058	20
S21406*	PLT/16W/V/LED/840/4P/DR	16	G24Q	4000K	82	6 ½	1850	50K	045923224065	20
S21407*	PLT/16W/V/LED/850/4P/DR	16	G24Q	5000K	82	6 ½	1850	50K	045923224072	20

♦ Visit www.satco.com for ballast compatibility list.

Satco 2G11 23W LED/CFL replacement lamps

Ballast bypass replacement
for 4-pin 40W PL-L

- Direct wire 120-277V
- All glass tube
- Over 40% energy savings
- Instant on to full brightness/no flickering
- Damp location
- NSF certified
- c-UL-us Classified
- Long life—50,000 hours
- 5 Year warranty



Wiring diagram

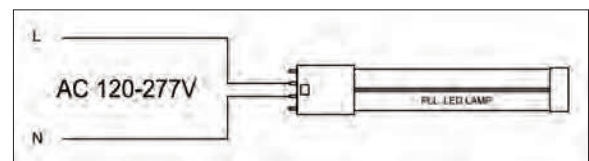

Satco 2G11 23W LED/CFL Replacement Lamps



Item Number	Lamp Description	W	CRI	Base Type	CCT	Lm	M.O.L. (Inches)	Life/ Hrs.	UPC	Pack
S9950*	23PLL/LED/835/BP	23	82	2G11	3500K	2600	22 ½	50K	045923099502	10
S9951*	23PLL/LED/840/BP	23	82	2G11	4000K	2800	22 ½	50K	045923099519	10

Satco 2', 3' & 6" U-bend LED T8 lamps

Direct replacement for linear or U-bend T8 fluorescent lamps in existing fixtures with instant or rapid start ballasts.

No rewiring required*

- Over 40% energy savings vs. standard T8 systems
- All glass tube
- Direct replacement solution allows the fixture to maintain the Original UL and CSA Compliance
- Compatible with emergency ballasts (2' & 3')**
- Integrated thermal fuse at pins
- Damp location
- DLC listed*
- NSF certified
- c-UL-us listed
- Long life—50,000 hours
- 5 Year warranty



LED T8 2', 3' & 6" U-Bend Ballast Compatible

Item Number	Lamp Description	W	CRI	Base Type	Bm	CCT	Lm	M.O.L. (Inches)	Life/Hrs.	UPC	Pack
2' LED T8**											
S9946*	8T8/LED/24-830/DR	8	82	Med Bi-Pin	220°	3000K	1200	24	50K	045923099465	10
S9947*	8T8/LED/24-835/DR	8	82	Med Bi-Pin	220°	3500K	1200	24	50K	045923099472	10
S9948*	8T8/LED/24-840/DR	8	82	Med Bi-Pin	220°	4000K	1250	24	50K	045923099489	10
S9949*	8T8/LED/24-850/DR	8	82	Med Bi-Pin	220°	5000K	1250	24	50K	045923099496	10
3' LED T8**											
S29990*	10T8/LED/36-830/DR	10	82	Med Bi-Pin	220°	3000K	1400	36	50K	045923099908	10
S29991*	10T8/LED/36-835/DR	10	82	Med Bi-Pin	220°	3500K	1400	36	50K	045923099915	10
S29992*	10T8/LED/36-840/DR	10	82	Med Bi-Pin	220°	4000K	1450	36	50K	045923099922	10
S29993*	10T8/LED/36-850/DR	10	82	Med Bi-Pin	220°	5000K	1450	36	50K	045923099939	10
U-Bend 6" LED T8											
S9994*	11.5T8U6/LED/22.5-830/DR	11.5	82	Med Bi-Pin	230°	3000K	1700	22.5	50K	045923099946	12
S9995*	11.5T8U6/LED/22.5-835/DR	11.5	82	Med Bi-Pin	230°	3500K	1700	22.5	50K	045923099953	12
S9996*	11.5T8U6/LED/22.5-840/DR	11.5	82	Med Bi-Pin	230°	4000K	1800	22.5	50K	045923099960	12
S9997*	11.5T8U6/LED/22.5-850/DR	11.5	82	Med Bi-Pin	230°	5000K	1800	22.5	50K	045923099977	12

* May not be compatible with all ballasts. Visit www.satco.com for an approved list.

** 2' & 3' May not be compatible with all rapid start and emergency ballasts. Visit www.satco.com for an approved list.

LED T8 LAMPS

Satco 12W, 4' LED T8 lamps

Direct replacement for linear fluorescent T8 lamps in existing fixtures with instant or rapid start ballasts. No rewiring required♦♦

- Over 40% energy savings vs. standard 4' T8 systems
- All glass tube
- Compatible with emergency* & dimming ballasts♦♦
- Integrated thermal fuse at pins
- Damp location
- c-UL-us listed
- NSF certified
- DLC listed*
- Long life—50,000 hours
- 5 Year warranty



LED T8 Ballast Compatible

Item Number	Lamp Description	W	CRI	Base Type	Bm	CCT	Lm	M.O.L. (Inches)	Life/ Hrs.	UPC	Pack
S29934*	12T8/LED/48-830/DR	12	82	G13	210°	3000K	1700	48	50K	045923299346	10
S29935*	12T8/LED/48-835/DR	12	82	G13	210°	3500K	1700	48	50K	045923299353	10
S29936*	12T8/LED/48-840/DR	12	82	G13	210°	4000K	1800	48	50K	045923299360	10
S29937*	12T8/LED/48-850/DR	12	82	G13	210°	5000K	1800	48	50K	045923299377	10

♦ May not be compatible with all instant start and rapid start ballasts. Visit www.satco.com for an approved list.

LED T8 Ballast Compatible



Item Number	Lamp Description	W	CRI	Base Type	Bm	CCT	Lm	M.O.L. (Inches)	Life/ Hrs.	UPC	Pack
Dimmable♦♦											
S29938*	12T8/LED/48-830/DR-DM	12	82	G13	210°	3000K	1700	48	50K	045923299384	10
S29939*	12T8/LED/48-835/DR-DM	12	82	G13	210°	3500K	1700	48	50K	045923299391	10
S29940*	12T8/LED/48-840/DR-DM	12	82	G13	210°	4000K	1800	48	50K	045923299407	10
S29941*	12T8/LED/48-850/DR-DM	12	82	G13	210°	5000K	1800	48	50K	045923299414	10

♦♦ May not be compatible with all instant start, rapid start, dimmable, and emergency ballasts. Visit www.satco.com for an approved list.

* DLC Listed

Satco 15W, 4' LED T8 lamps

Direct replacement for linear fluorescent T8 lamps in existing fixtures with instant or rapid start ballasts. No rewiring required♦

- Over 40% energy savings vs standard 4' T8 systems
- All glass tube
- Direct replacement solution allows the fixture to maintain the Original UL and CSA Compliance
- Integrated thermal fuse at pins
- Damp location
- c-UL-us listed
- DLC listed*
- Long life—50,000 hours
- 5 Year warranty



LED T8 Ballast Compatible

Item Number	Lamp Description	W	CRI	Base Type	Bm	CCT	Lm	M.O.L. (Inches)	Life/Hrs.	UPC	Pack
S29975*	15T8/LED/48-830/DR	15	80	Med Bi-Pin	220°	3000K	2100	48	50K	045923099755	10
S29976*	15T8/LED/48-835/DR	15	80	Med Bi-Pin	220°	3500K	2100	48	50K	045923099762	10
S29977*	15T8/LED/48-840/DR	15	80	Med Bi-Pin	220°	4000K	2200	48	50K	045923099779	10
S29978*	15T8/LED/48-850/DR	15	80	Med Bi-Pin	220°	5000K	2200	48	50K	045923099786	10

♦ May not be compatible with all instant start and rapid start ballasts. Visit www.satco.com for an approved list.

Linear LED ballast bypass T8 series

Double ended wiring

- Works with existing sockets –shunted or non-shunted
- Reduces labor costs for installation
- Built-in shock resistant circuit (not hot until both ends are installed)
- No ballast or external driver required
- Direct wire 120-277V line voltage
- All glass tube
- Approved for use with tube guards
- Damp location
- c-UL-us Classified
- DLC Listed
- Long life—50,000 hours
- 5 Year warranty



Double Ended
Wiring Diagram

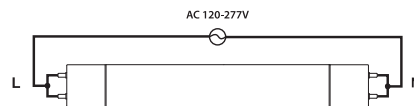

LED T8 Ballast Bypass



Item Number	Lamp Description	W	CRI	Base Type	Bm	CCT	Lm	M.O.L. (Inches)	Life/ Hrs.	UPC	Pack
9W, 2'											
S29900	9T8/LED/24-830/BP 120-277V	9	82	Med Bi-Pin	220°	3000K	1100	24	50K	045923299001	25
S29901	9T8/LED/24-835/BP 120-277V	9	82	Med Bi-Pin	220°	3500K	1100	24	50K	045923299018	25
S29902	9T8/LED/24-840/BP 120-277V	9	82	Med Bi-Pin	220°	4000K	1150	24	50K	045923299025	25
S29903	9T8/LED/24-850/BP 120-277V	9	82	Med Bi-Pin	220°	5000K	1150	24	50K	045923299032	25
12W, 3'											
S29926	12T8/LED/36-830/BP 120-277V	12	82	Med Bi-Pin	220°	3000K	1400	36	50K	045923299261	25
S29927	12T8/LED/36-835/BP 120-277V	12	82	Med Bi-Pin	220°	3500K	1400	36	50K	045923299278	25
S29928	12T8/LED/36-840/BP 120-277V	12	82	Med Bi-Pin	220°	4000K	1450	36	50K	045923299285	25
S29929	12T8/LED/36-850/BP 120-277V	12	82	Med Bi-Pin	220°	5000K	1450	36	50K	045923299292	25
14W, 4'											
S29913	14T8/LED/48-830/BP 120-277V	14	82	Med Bi-Pin	220°	3000K	1800	48	50K	045923299131	25
S29914	14T8/LED/48-835/BP 120-277V	14	82	Med Bi-Pin	220°	3500K	1800	48	50K	045923299148	25
S29915	14T8/LED/48-840/BP 120-277V	14	82	Med Bi-Pin	220°	4000K	1800	48	50K	045923299155	25
S29916	14T8/LED/48-850/BP 120-277V	14	82	Med Bi-Pin	220°	5000K	1800	48	50K	045923299162	25
17W, 4'											
S29904	17T8/LED/48-830/BP 120-277V	17	82	Med Bi-Pin	220°	3000K	2100	48	50K	045923299049	25
S29905	17T8/LED/48-835/BP 120-277V	17	82	Med Bi-Pin	220°	3500K	2100	48	50K	045923299056	25
S29906	17T8/LED/48-840/BP 120-277V	17	82	Med Bi-Pin	220°	4000K	2200	48	50K	045923299063	25
S29907	17T8/LED/48-850/BP 120-277V	17	82	Med Bi-Pin	220°	5000K	2200	48	50K	045923299070	25

LED T8 LAMPS

15W Linear LED ballast bypass T8 series

Direct wire replacement for linear fluorescent T8 lamps in existing fixtures. Single ended wiring/non-shunted sockets.

- Single ended wiring/non-shunted sockets
- No ballast or external driver required
- Direct wire 120-277V line voltage**
- All glass tube
- Damp location
- c-UL-us Classified
- DLC listed*
- Long life—50,000 hours
- 5 Year warranty



Single Ended Wiring Diagram

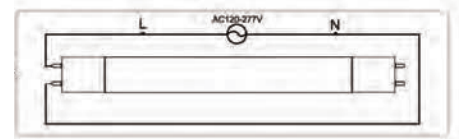

Wiring harnesses available including non-shunted sockets, sold separately

Item Number	Description
80/2626	1 LT BALLAST BYPASS WIRING HARNESS
80/2627	2 LT BALLAST BYPASS WIRING HARNESS
80/2628	3 LT BALLAST BYPASS WIRING HARNESS
80/2629	4 LT BALLAST BYPASS WIRING HARNESS

LED T8 Ballast Bypass

Item Number	Lamp Description	W	CRI	Base Type	Bm	CCT	Lm	M.O.L. (Inches)	Life/Hrs.	UPC	Pack
S9720*	15T8/LED/48-830/BP	15	82	Med Bi-Pin	230°	3000K	1700	48	50K	045923097201	10
S9721*	15T8/LED/48-835/BP	15	82	Med Bi-Pin	230°	3500K	1700	48	50K	045923097218	10
S9722*	15T8/LED/48-840/BP	15	82	Med Bi-Pin	230°	4000K	1800	48	50K	045923097225	10
S9723*	15T8/LED/48-850/BP	15	82	Med Bi-Pin	230°	5000K	1800	48	50K	045923097232	10

** Install on non-shunted lampholders



Linear LED ballast bypass T8 U-bend series

- No ballast or external driver required
- Direct wire 120-277V line voltage**
- All glass tube
- Damp location
- c-UL-us Classified
- DLC listed*
- Long life—50,000 hours
- 5 Year warranty



Wiring Diagram

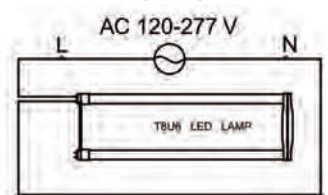

Linear LED Ballast Bypass T8 U-Bend Series

Item Number	Lamp Description	W	V	CRI	CCT	Lm	Bm	M.O.L. (inches)	Life/Hrs.	UPC	Pack
S9930*	15T8U6/LED/22.5-830/BP	15	120-277	82	3000K	1700	220°	22 ½	50K	045923099304	12
S9931*	15T8U6/LED/22.5-835/BP	15	120-277	82	3500K	1700	220°	22 ½	50K	045923099311	12
S9932*	15T8U6/LED/22.5-840/BP	15	120-277	82	4000K	1800	220°	22 ½	50K	045923099328	12
S9933*	15T8U6/LED/22.5-850/BP	15	120-277	82	5000K	1800	220°	22 ½	50K	045923099335	12

** Install on non-shunted lampholders



LED T8 LAMPS

43W Linear LED ballast bypass 8' T8 series

- Double ended wiring
- Shatterproof coated
- Over 40% energy savings vs standard 8' T8 systems
- Slimline single pin base - replaces T8 & T12
- No ballast or external driver required
- Direct wire 120-277V line voltage
- All glass tube
- Damp location
- NSF certified
- c-UL-us Classified
- Long life—50,000 hours
- 5 Year warranty



Wiring Diagram

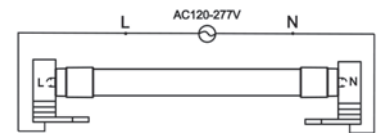

LED T8 Ballast Bypass

Item Number	Lamp Description	W	CRI	Base Type	Bm	CCT	Lm	M.O.L. (Inches)	Life/ Hrs.	UPC	Pack
S9917*	43T8/LED/96-835/BP	43	82	Single Pin	210°	3500K	5500	96	50K	045923099175	10
S9918*	43T8/LED/96-840/BP	43	82	Single Pin	210°	4000K	5500	96	50K	045923099182	10
S9919*	43T8/LED/96-850/BP	43	82	Single Pin	210°	5000K	5500	96	50K	045923099199	10

43W Linear LED ballast bypass 8' T8 series

- Double ended wiring
- Shatterproof coated
- Over 40% energy savings vs standard 8' T8 systems
- R17d base designed to replace 8' T8 HO and T12 HO Fluorescent lamps
- No ballast or external driver required
- Direct wire 120-277V line voltage
- All glass tube
- Damp location
- NSF certified
- c-UL-us Classified
- Long life—50,000 hours
- 5 Year warranty



Wiring Diagram

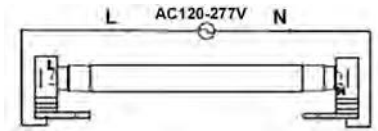

LED T8 Ballast Bypass

Item Number	Lamp Description	W	CRI	Base Type	Bm	CCT	Lm	M.O.L. (Inches)	Life/ Hrs.	UPC	Pack
S9924	43T8/LED/96-840/BP/R17d	43	82	R17d	210°	4000K	5500	96	50K	045923099243	10
S9925	43T8/LED/96-850/BP/R17d	43	82	R17d	210°	5000K	5500	96	50K	045923099250	10
S9942	43T8/LED/96-865/BP/R17d	43	82	R17d	210°	6500K	5500	96	50K	045923099427	10

LED T5 LAMPS

25W, 4' Linear LED T5 lamps

Direct replacement for linear fluorescent F54T5HO lamps in existing fixtures with electronic ballasts. No rewiring required*

- Over 50% energy savings vs. standard 4' T5 systems
- All glass tube
- Compatible with rapid start ballasts*
- Integrated thermal fuse at pins
- Damp location • NSF certified
- c-UL-us listed • DLC listed*
- Long life—50,000 hours
- 5 Year warranty



LED T5 Ballast Compatible

Item Number	Lamp Description	W	CRI	Base Type	Bm	CCT	Lm	Nominal (M.O.L.)	Life/ Hrs.	UPC	Pack
S29912*	25T5/LED/46-835/DR	25	82	G5	185°	3500K	3300	48 (46)	50K	045923097126	10
S29910*	25T5/LED/46-840/DR	25	82	G5	185°	4000K	3500	48 (46)	50K	045923097102	10
S29911*	25T5/LED/46-850/DR	25	82	G5	185°	5000K	3500	48 (46)	50K	045923097119	10

* May not be compatible with all rapid start ballasts. Visit www.satco.com for an approved list.

Satco LED T5 ballast bypass series

Ballast bypass replacement for linear fluorescent T5 HO & HE lamps in existing fixtures.

- No ballast or external driver required
- Available in 2', 3' & 4'
- Direct wire 120-277V line voltage
- All glass tube • PET-shatterproof coated
- Damp location • c-UL-us Classified
- NSF certified • DLC listed*
- Long life—50,000 hours
- 5 Year warranty

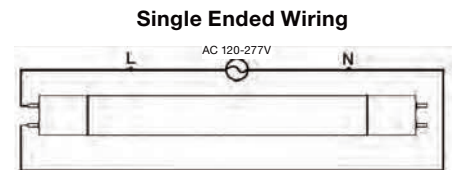

LED T5 Ballast Bypass Lamps

Item Number	Lamp Description	W	V	CRI	Base Type	Bm	CCT	Lm	Nominal (M.O.L.)	Life/ Hrs.	UPC	Pack
S8693	12T5/LED/24-835/BP/HO	12	120-277	83	G5	240°	3500K	1400	24 (22.5)	50K	045923086939	25
S8694	12T5/LED/24-840/BP/HO	12	120-277	83	G5	240°	4000K	1450	24 (22.5)	50K	045923086946	25
S8695	12T5/LED/24-850/BP/HO	12	120-277	83	G5	240°	5000K	1500	24 (22.5)	50K	045923086953	25
S8696	16T5/LED/36-835/BP/HO	16	120-277	83	G5	240°	3500K	1800	36 (34)	50K	045923086960	25
S8697	16T5/LED/36-840/BP/HO	16	120-277	83	G5	240°	4000K	1850	36 (34)	50K	045923086977	25
S8698	16T5/LED/36-850/BP/HO	16	120-277	83	G5	240°	5000K	1900	36 (34)	50K	045923086984	25
S8690*	13T5/LED/46-835/BP/HE	13	120-277	83	G5	240°	3500K	1600	48 (46)	50K	045923086908	25
S8691*	13T5/LED/46-840/BP/HE	13	120-277	83	G5	240°	4000K	1650	48 (46)	50K	045923086915	25
S8692*	13T5/LED/46-850/BP/HE	13	120-277	83	G5	240°	5000K	1700	48 (46)	50K	045923086922	25
S29717*	25T5/LED/46-835/BP/HO	25	120-277	83	G5	240°	3500K	3200	48 (46)	50K	045923297175	25
S29718*	25T5/LED/46-840/BP/HO	25	120-277	83	G5	240°	4000K	3300	48 (46)	50K	045923297182	25
S29719*	25T5/LED/46-850/BP/HO	25	120-277	83	G5	240°	5000K	3400	48 (46)	50K	045923297199	25

LED T5 LAMPS

Satco LED T5 mini bi-pin (G5) ballast bypass series

Ballast bypass replacement for mini bi-pin linear fluorescent T5 preheat lamps in existing fixtures.

- No ballast or external driver required
- Available in 6", 9", 12", & 21"
- Direct wire 120-277V line voltage
- PET Shatterproof coated
- Damp location
- c-UL-us classified
- Long life—50,000 hours
- 5 Year warranty



Double Ended Wiring

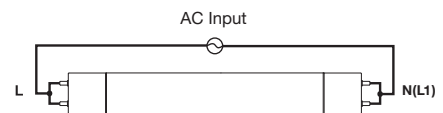

LED T5 Mini Bi-Pin Ballast Bypass Lamps

Item Number	Lamp Description	Replaces	W	V	CRI	Base Type	Bm	CCT	Lm	M.O.L. (Nominal)	Length (Inches)	Life/Hrs.	UPC	Pack
S11900	2W/LED/T5/840	F4T5/CW	2	120-277	80	G5	240°	4000K	150	5 29/32	6	50K	045923119002	10
S11901	2W/LED/T5/865	F4T5/D	2	120-277	80	G5	240°	6500K	150	5 29/32	6	50K	045923119019	10
S11902	3W/LED/T5/840	F6T5/CW	3	120-277	80	G5	240°	4000K	270	8 29/32	9	50K	045923119026	10
S11903	3W/LED/T5/865	F6T5/D	3	120-277	80	G5	240°	6500K	270	8 29/32	9	50K	045923119033	10
S11904	4W/LED/T5/830	F8T5/WW	4	120-277	80	G5	240°	3000K	400	11 29/32	12	50K	045923119040	10
S11905	4W/LED/T5/840	F8T5/CW	4	120-277	80	G5	240°	4000K	400	11 29/32	12	50K	045923119057	10
S11906	4W/LED/T5/865	F8T5/D	4	120-277	80	G5	240°	6500K	400	11 29/32	12	50K	045923119064	10
S11907	7W/LED/T5/830	F13T5/WW	7	120-277	80	G5	240°	3000K	700	20 29/32	21	50K	045923119071	10
S11908	7W/LED/T5/840	F13T5/CW	7	120-277	80	G5	240°	4000K	700	20 29/32	21	50K	045923119088	10
S11909	7W/LED/T5/865	F13T5/D	7	120-277	80	G5	240°	6500K	700	20 29/32	21	50K	045923119095	10

LED T8 dual mode (ballast bypass/ ballast compatible) 1-5/8" u-bend lamps

Direct replacements for fluorescent T8 u-bend lamps in existing fixtures with or without ballasts.

- Over 50% energy savings vs. standard T8 systems
- Ballast compatible and ballast bypass in one lamp
- Bypass mode works in single or double ended wiring†
- Protection from arcing
- 120-277V in bypass mode
- Damp location
- NSF certified
- DLC 4.2 listed
- C-UL-us listed—ballast compatible
- c-UL-us Classified—ballast bypass
- Long life—50,000 hours
- 5 Year warranty**



LED T8 Dual Mode U-bend Lamps—Ballast Compatible



Item Number	Lamp Description	W	CRI	CCT	Lm	M.O.L. (Inches)	Life/Hrs.	UPC	Pk./Mstr.
S18450	13T8/U1-G13/LED/830/DUAL	13	80	3000K	1800	22 ½	50K	045923184505	24
S18451	13T8/U1-G13/LED/835/DUAL	13	80	3500K	1800	22 ½	50K	045923184512	24
S18452	13T8/U1-G13/LED/840/DUAL	13	80	4000K	1900	22 ½	50K	045923184529	24
S18453	13T8/U1-G13/LED/850/DUAL	13	80	5000K	2000	22 ½	50K	045923184536	24

May not be compatible with all instant start, rapid start, dimmable, and emergency ballasts. Visit www.satco.com for an approved list.

** See separate warranty for complete terms and conditions.

LED T8 Dual Mode U-bend Lamps—Ballast Bypass



Item Number	Lamp Description	W	V	CRI	CCT	Lm	M.O.L. (Inches)	Life/Hrs.	UPC	Pk./Mstr.
S18450	13T8/U1-G13/LED/830/DUAL	13	120-277	80	3000K	1800	22 ½	50K	045923184505	24
S18451	13T8/U1-G13/LED/835/DUAL	13	120-277	80	3500K	1800	22 ½	50K	045923184512	24
S18452	13T8/U1-G13/LED/840/DUAL	13	120-277	80	4000K	1900	22 ½	50K	045923184529	24
S18453	13T8/U1-G13/LED/850/DUAL	13	120-277	80	5000K	2000	22 ½	50K	045923184536	24

LED T8 LAMPS

LED T8 dual mode (ballast bypass/ ballast compatible) linear lamps

Direct replacements for fluorescent T8 lamps in existing fixtures with or without ballasts.

- Over 40% energy savings vs. standard T8 systems
- Ballast compatible (12W) and ballast bypass (13W) in one lamp
- Bypass mode works in single or double ended wiring♦♦
- Protection from arcing***
- All glass tube
- Compatible with emergency and dimming ballasts*
- 120-277V in bypass mode
- Damp location
- PET coated
- NSF certified
- DLC 4.2 listed
- C-UL-us listed—ballast compatible
- c-UL-us Classified—ballast bypass
- Long life—50,000 hours
- 5 Year warranty**



LED T8 Dual Mode Linear Lamps

Item Number	Lamp Description	W	CRI	CCT	Lm	Bm	M.O.L. (Inches)	Life/Hrs.	UPC	Pack/Master
Ballast Compatible*										
S8890	12T8/LED/48-830/DUAL/BP-DR	12	83	3000K	1800	240°	48	50K	045923088902	25
S8891	12T8/LED/48-835/DUAL/BP-DR	12	83	3500K	1800	240°	48	50K	045923088919	25
S8892	12T8/LED/48-840/DUAL/BP-DR	12	83	4000K	1900	240°	48	50K	045923088926	25
S8893	12T8/LED/48-850/DUAL/BP-DR	12	83	5000K	1900	240°	48	50K	045923088933	25

* May not be compatible with all instant start, rapid start, dimmable, and emergency ballasts. Visit www.satco.com for an approved list.

** See separate warranty for complete terms and conditions.



LED T8 Dual Mode Linear Lamps

Item Number	Lamp Description	W	V	CRI	CCT	Lm	Bm	M.O.L. (Inches)	Life/Hrs.	UPC	Pack/Master
Ballast Bypass**											
S8890	13T8/LED/48-830/DUAL/BP-DR	13	120-277	83	3000K	1800	240°	48	50K	045923088902	25
S8891	13T8/LED/48-835/DUAL/BP-DR	13	120-277	83	3500K	1800	240°	48	50K	045923088919	25
S8892	13T8/LED/48-840/DUAL/BP-DR	13	120-277	83	4000K	1900	240°	48	50K	045923088926	25
S8893	13T8/LED/48-850/DUAL/BP-DR	13	120-277	83	5000K	1900	240°	48	50K	045923088933	25

* May not be compatible with all instant start, rapid start, dimmable, and emergency ballasts. Visit www.satco.com for an approved list.

♦♦ Bypass mode works wired as a single ended lamp on non-shunted sockets or as a double ended lamp on either shunted or non-shunted sockets.

** See separate warranty for complete terms and conditions.

LED T8 dual mode linear lamps

(Cont'd. from page 84)

Wiring–Ballast Compatible

- For instant start ballasts on the approved list, ensure that LED/fluorescent sockets are wired in a shunt configuration according to manufacturer's wiring diagram.
- For rapid start ballasts on the approved list, non-shunted LED/fluorescent sockets are needed and wired according to manufacturer's wiring diagram.

Wiring Options–Ballast Bypass - 120-277V

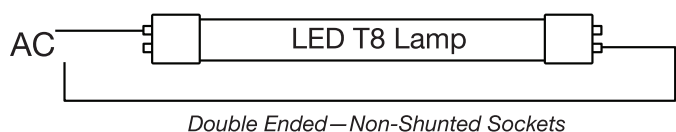
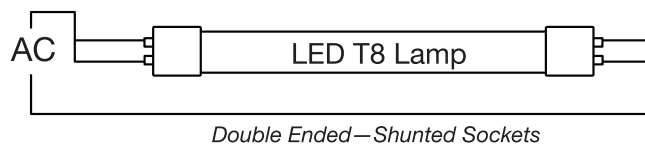
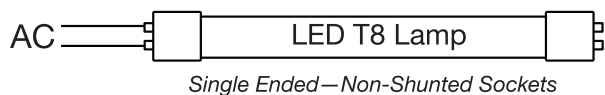

System Performance - LED T8 Dual Mode Linear Lamps–Ballast Compatible

System Performance Chart				Bare Lamp (Rated)		Bare Lamp Wattage			System Wattage			Initial Lumens			Lifetime		
Item Nmbr	Description	CCT	Length (ft)	Nominal Wattage	Nominal Lumens	LBF (0.78)	NBF (0.88)	HBF (1.18)	LBF (0.78)	NBF (0.88)	HBF (1.18)	LBF (0.78)	NBF (0.88)	HBF (1.18)	LBF (0.78)	NBF (0.88)	HBF (1.18)▼
S8890	12T8/LED/48-830/DUAL/BP-DR	3000K	4	12	1800	11.0	12.0	17	13.5	15.5	20.0	1600	1800	2500	>50Khrs	>50Khrs	50Khrs
S8891	12T8/LED/48-835/DUAL/BP-DR	3500K	4	12	1800	11.0	12.0	17	13.5	15.5	20.0	1600	1800	2500	>50Khrs	>50Khrs	50Khrs
S8892	12T8/LED/48-840/DUAL/BP-DR	4000K	4	12	1900	11.0	12.0	17	13.5	15.5	20.0	1700	1900	2600	>50Khrs	>50Khrs	50Khrs
S8893	12T8/LED/48-850/DUAL/BP-DR	5000K	4	12	1900	11.0	12.0	17	13.5	15.5	20.0	1700	1900	2600	>50Khrs	>50Khrs	50Khrs

*** Power must be turned off prior to installing lamps. Sockets must be in good working order, not broken, cracked or electrically compromised. If arcing occurs at the lamp pin, thermal fuse may activate to avoid overheating of lamp.

▼ LED tube life will change with ballast factor, configurations producing ballast factors above 1.18 are not allowed.

LED T9 CIRCLINE LAMPS

8" and 12" T9 LED ballast bypass Circline lamps

- No ballast or external driver required
- Over 40% energy savings vs. standard T9 systems
- Replaces 22W and 32W fluorescent Circlines
- 120-277V (direct wire)
- Damp location
- NSF certified
- c-ETL-us listed
- Long life—50,000 hours
- 5 Year warranty



12"–16 Watt



8"–11 Watt

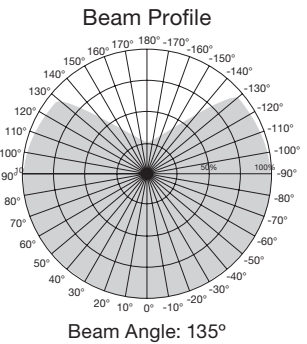

LED T9 8" and 12" Circline Lamps



Item Number	Lamp Description	W	CRI	Base Type	V	Bm	CCT	Lm	M.O.L. (Inches)	Life/Hrs.	UPC	Pack
S16500	FC8T9/11W/LED/CIR/830/BP	11	80	G10Q	120-277	135°	3000K	1100	8	50K	045923165009	20
S16501	FC8T9/11W/LED/CIR/840/BP	11	80	G10Q	120-277	135°	4000K	1210	8	50K	045923165016	20
S16502	FC8T9/11W/LED/CIR/865/BP	11	80	G10Q	120-277	135°	6500K	1210	8	50K	045923165023	20
S16503	FC12T9/16W/LED/CIR/830/BP	16	80	G10Q	120-277	135°	3000K	1600	12	50K	045923165030	20
S16504	FC12T9/16W/LED/CIR/840/BP	16	80	G10Q	120-277	135°	4000K	1760	12	50K	045923165047	20
S16505	FC12T9/16W/LED/CIR/865/BP	16	80	G10Q	120-277	135°	6500K	1760	12	50K	045923165054	20

LED T8 & T5 LAMPS

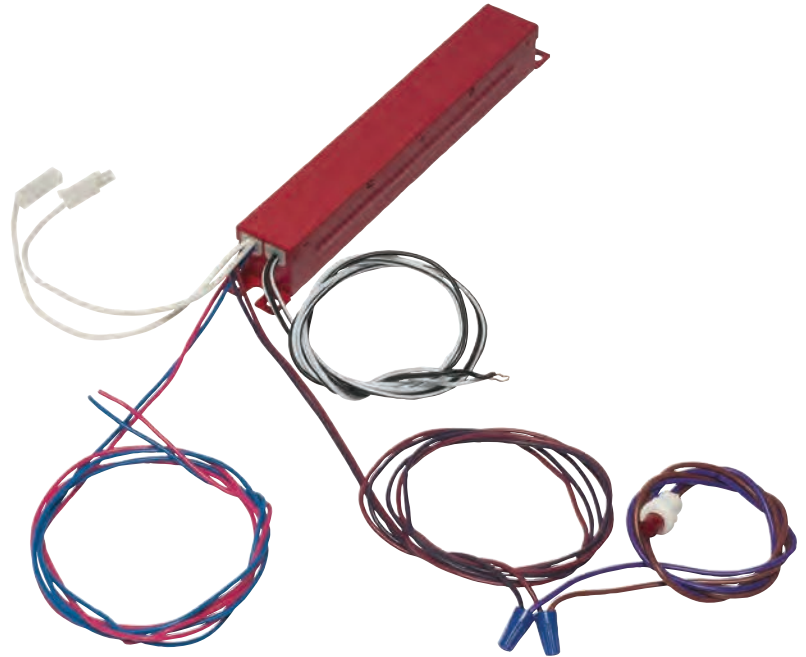

Emergency battery backup and LED driver.

For LED T8 and T5 ballast bypass lamps.

- 5 Watt output power
- 1.8 Watt standby power
- 90 minute battery run time at 5W
- Output and over-power protection
- Lithium Ion battery
- 0°C-50°C Operating temperature
- Recharge 24 hours max
- 5 Year warranty

For use with the following lamps:

1. Satco 4' T8 (S9720-S9723)
2. Satco U-Bend (S9930-S9933)
3. Satco 4' T5 LED bypass lamps (S29717-S29719)
4. Satco new generation double ended bypass lamps (S29900-S29907, S29926-S29929, S29913-S29916)

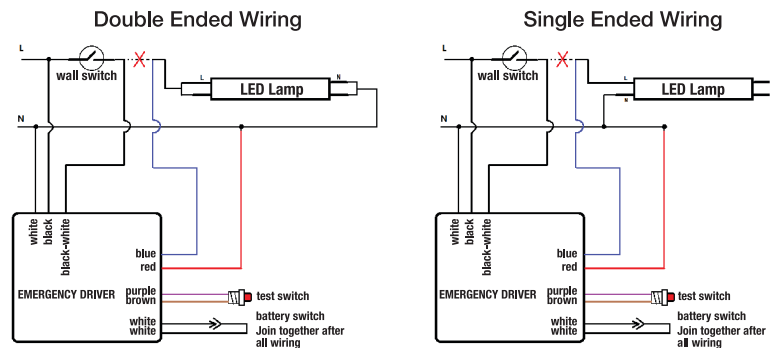
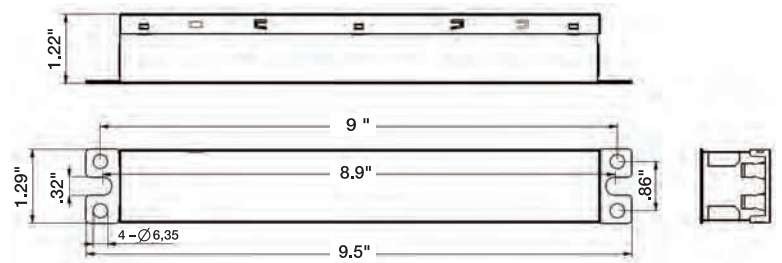

Emergency Battery Backup & LED Driver—For LED T8 and T5 Ballast Bypass Lamps

Item Number	Description	W	V	M.O.L. (inches)	Dimensions	UPC	Case
S8000	5W Emergency LED driver	5	120-277	9.5	1.3"W x 1.22"H x 9.5"L	045923080005	25

LED T8 LAMPS

LED T8 sign lamps

- Over 40% savings vs. standard T8 systems
- 2', 3', 4', 5', 6' & 8' Lengths
- Base rotates 90° for easy installation
- Wide, 330° beam angle
- CRI >83
- No ballast and no external driver required
- Direct wire 120-277V line voltage
- Damp location
- NSF Certified
- C-UL-us Classified
- Long life—50,000 hours
- 5 Year warranty**



Wiring Diagram - AC 120-277V
Single Ended Wiring Required

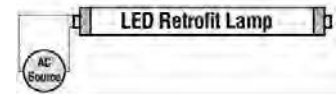

LED T8 Sign Lamps



Item Number	Lamp Description	W	CRI	Base	CCT	Lm	Nominal (MOL)	Life/Hrs.	UPC	Pk./Mstr.
S16400	9T8/LED/HO-SIGN/24-840/BP	9	83	R17D	4000K	1200	24 (21.9)	50K	045923164002	10
S16401	9T8/LED/HO-SIGN/24-865/BP	9	83	R17D	6500K	1200	24 (21.9)	50K	045923164019	10
S16402	12T8/LED/HO-SIGN/36-840/BP	12	83	R17D	4000K	1500	36 (33.9)	50K	045923164026	10
S16403	12T8/LED/HO-SIGN/36-865/BP	12	83	R17D	6500K	1500	36 (33.9)	50K	045923164033	10
S16404	18T8/LED/HO-SIGN/48-840/BP	18	83	R17D	4000K	2300	48 (46.0)	50K	045923164040	10
S16405	18T8/LED/HO-SIGN/48-865/BP	18	83	R17D	6500K	2300	48 (46.0)	50K	045923164057	10
S16406	24T8/LED/HO-SIGN/60-840/BP	24	83	R17D	4000K	3100	60 (57.9)	50K	045923164064	10
S16407	24T8/LED/HO-SIGN/60-865/BP	24	83	R17D	6500K	3100	60 (57.9)	50K	045923164071	10
S16408	30T8/LED/HO-SIGN/72-840/BP	30	83	R17D	4000K	4100	72 (69.9)	50K	045923164088	10
S16409	30T8/LED/HO-SIGN/72-865/BP	30	83	R17D	6500K	4100	72 (69.9)	50K	045923164095	10
S16410	36T8/LED/HO-SIGN/96-840/BP	36	83	R17D	4000K	5000	96 (93.9)	50K	045923164101	10
S16411	36T8/LED/HO-SIGN/96-865/BP	36	83	R17D	6500K	5000	96 (93.9)	50K	045923164118	10